

LA9520V

Operating Conditions at $T_a = 25^\circ\text{C}$

Parameter	Symbol	Conditions	Ratings	Unit
Recommended supply voltage	V_{CC}		5.0	V
Allowable operating voltage range	$V_{CC\text{ opg}}$		4.8 to 6.0	V

Electrical Characteristics at $T_a = 25^\circ\text{C}$, $V_{CC} = 5\text{ V}$

Representative input conditions: Carrier input frequency - Audio left channel: 4.3 MHz

Audio right channel: 4.8 MHz

Video: 11.8 MHz

Audio modulation frequency: $f_m = 400\text{ Hz}$, 1 kHz , modulation $\Delta f = \pm 22.5\text{ kHz}$ (standard), $\pm 75\text{ kHz}$

Video signal input: Modulation of 2 MHz (standard) for a 0.5 Vp-p NTSC composite video signal

With the circuit adjusted to an audio demodulated output of 300 mVrms and a video demodulated output of 1 Vp-p for the above standard input.

Parameter	Symbol	Conditions	Ratings			Unit
			min	typ	max	
Current drain	I_{CC}	No input, $V_{CC} = 5\text{ V}$, Test pins: 3, 7, 2, 5, and 32	45	68	83	mA
[Preamplifier Block] *An unmodulated carrier input is used for preamplifier block testing.						
Preamplifier frequency characteristics	F_{pre}	Pin 9 input. The -3 dB frequency band, $f = 11.8\text{ MHz}$, $V_{IN} = 70\text{ dB}\mu$, Test pin: 31		20		MHz
Input impedance	Z_{in}	Pin 9 internal voltage conversion resistor, Test pin: 9	0.3	0.5	1.0	k Ω
Output level	V_{outpre}	The output level when the AGC is on, $V_{IN} = 100\text{ dB}\mu$, Test pin: 31	0.55	0.9	1.5	Vp-p
Gain (AGC off)	G_{vpre}	$f = 11.8\text{ MHz}$, $V_{IN} = 70\text{ dB}\mu$, Test pin: 31	17	23	29	dB
Harmonic distortion 1	TH1Pre	The second harmonic of 12.5 MHz, $V_{IN} = 100\text{ dB}\mu$, Test pin: 31		-40		dB
[Video Block]						
Video amplifier gain adjustment voltage	V_{vcont}	Pin 9 input. For a 2 MHz modulated input, The voltage such that the pin 1 output level becomes 1 Vp-p, $V_{IN} = 100\text{ dB}\mu$, Test pin: 35	0.05		1.15	Vdc
Demodulator linearity	LINdeomo	Pin 36 input. The conversion voltage ratio linearity at the points $\pm 3.5\text{ MHz}$ from the 12.5 MHz reference. $V_{IN} = 100\text{ dB}\mu$, Test pin: 33	-7	0	+7	%
Demodulator demodulation leakage	V_{leak}	Pin 36 input. The pin 33 leakage when a carrier frequency of 12.5 MHz is applied. $V_{IN} = 100\text{ dB}\mu$, Test pin: 33		-50		dB
Demodulator second harmonic distortion	THD2	Pin 36 input. The second harmonic leakage level when a carrier frequency of 12.5 MHz is applied. $V_{IN} = 100\text{ dB}\mu$, Test pin: 33		-55		dB
Demodulator conversion output	$V_{conv.}$	Pin 36 input. The output value when a 2 MHz modulated waveform is input, $V_{IN} = 100\text{ dB}\mu$, Test pin: 33	0.1	0.23	0.4	Vp-p
Video amplifier gain	G_{Vamp}	Pin 34 input. With a 75 Ω load on pin 1, the total gain after adjusting the output to be 1 Vp-p, $f = 150\text{ kHz}$. $V_{IN} = 0.1\text{ Vp-p}$, Test pin: 1		13		dB
Video harmonic distortion 1	THD1V	The second harmonic of 150 kHz, $V_{IN} = 0.1\text{ Vp-p}$ Test pin: 1		-50		dB
Video harmonic distortion 2	THD2V	The second harmonic of 11 MHz, $V_{IN} = 0.1\text{ Vp-p}$ Test pin: 1		-48		dB
Video driver frequency characteristics	F_{vamp}	The gain ratio for 150 kHz and 5 MHz. $V_{IN} = 0.1\text{ Vp-p}$ Test pin: 1	-6	-3	+3	dB
Driver maximum output voltage	V_{outmax}	$V_{CC} = 5\text{ V}$, the maximum output amplitude with a 75 Ω load. Test pin: 1	1.2	1.5		Vp-p
DC clamp level difference	VCLMP	The difference between the pin 4 and the pin 5 voltages with no input. Test pins: 4 and 5	0.05	0.5		Vdc

Continued on next page.

LA9520V

Continued from preceding page.

Parameter	Symbol	Conditions	Ratings			Unit
			min	typ	max	
[Audio Block] * Audio block initial output is adjusted with the pin 9 input.						
Audio left channel Output adjustment voltage	VacontL	For a 4.3 MHz, $\Delta f = \pm 22.5$ kHz, $f_m = 400$ Hz input, the pin 14 adjustment voltage such that the pin 20 output is 30 mV rms. $V_{IN} = 80$ dB μ , Test pin: 14	0.05		1.15	Vdc
Audio right channel Output adjustment voltage	VacontR	For a 4.8 MHz, $\Delta f = \pm 22.5$ kHz, $f_m = 400$ Hz input, the pin 15 adjustment voltage such that the pin 21 output is 30 mV rms. $V_{IN} = 80$ dB μ , Test pin: 15	0.05		1.15	Vdc
Audio right channel demodulator output	VdemR 75 kHz	After reference output adjustment, the pin 21 demodulator output when the input to pin 26 is 4.8 MHz ± 75 kHz, $f_m = 1$ kHz, $V_{IN} = 80$ dB μ , Test pin: 21	0.6	0.9	1.2	Vrms
Audio left channel demodulator output	VdemL 75 kHz	After reference output adjustment, the pin 20 demodulator output when the input to pin 28 is 4.3 MHz ± 75 kHz, $f_m = 1$ kHz, $V_{IN} = 80$ dB μ , Test pin: 20	0.6	0.9	1.2	Vrms
Audio left channel amplifier output	GvampL	The total amplifier gain (after output level adjustment) from the pin 23 input to the pin 20 output. $V_{IN} = 100$ mVrms, $f = 400$ Hz., Test pin: 20		10		dB
Audio right channel amplifier output	GvampR	The total amplifier gain (after output level adjustment) from the pin 16 input to the pin 21 output. $V_{IN} = 100$ mVrms, $f = 400$ Hz., Test pin: 21		10		dB
Audio amplifier frequency characteristics (L)	FA-AMP L	The frequency characteristics (after output level adjustment) from pin 23 to pin 20. The frequency such that the level is down -3 dB from the output reference at $f = 400$ Hz, Test pin: 20	15			kHz
Audio amplifier frequency characteristics (R)	FA-AMP R	The frequency characteristics (after output level adjustment) from pin 16 to pin 21. The frequency such that the level is down -3 dB from the output reference at $f = 400$ Hz, Test pin: 21	15			kHz
Left channel total harmonic distortion	THDL	The left channel distortion when a 4.3 MHz, $\Delta f = \pm 22.5$ kHz, $f_m = 1$ kHz signal is input to pin 28. $V_{IN} = 80$ dB μ , Test pin: 20		1.0	3	%
Right channel total harmonic distortion	THDR	The right channel distortion when a 4.8 MHz, $\Delta f = \pm 22.5$ kHz, $f_m = 1$ kHz signal is input to pin 26. $V_{IN} = 80$ dB μ , Test pin: 21		1.0	3	%
Left channel output noise voltage	V_{NLch}	With no modulation, the standard output reference signal-to-noise ratio IHFA filter, the LA9520V independent signal-to-noise ratio, $V_{IN} = 80$ dB μ , Test pin: 20	45	55		dB
Right channel output noise voltage	V_{NRch}	With no modulation, the standard output reference signal-to-noise ratio IHFA filter, the LA9520V independent signal-to-noise ratio, $V_{IN} = 80$ dB μ , Test pin: 21	45	55		dB
[Muting Block]						
Audio muting operating input level 1 (Muting level adjustment voltage)	Vmcont1	With no carrier input, the value of the voltage adjusted to mute the audio output. * With an external 30 dB amplifier connected to pin 9. $R_g = 4.7$ k Ω Test pin: 13	0.05		1.05	Vdc
Video muting operating input level 2 (Muting level adjustment voltage)	Vmcont2	With no carrier input, the value of the voltage adjusted to mute the audio output. * With an external 30 dB amplifier connected to pin 9. $R_g = 4.7$ k Ω Test pin: 12	0.05		1.05	Vdc
Muted signal output Low level	VmuteL	The pin 29 output when the muting function is off. Test pin: 29			0.5	Vdc
Muted signal output High level	VmuteH	The pin 29 output when the muting function is on. Test pin: 29	$V_{CC} - 1$			Vdc
Noise detection voltage level	VDET	The pin 11 voltage with no carrier input. With an external 30 dB amplifier connected to pin 9.		3.0		Vdc

Pin Assignment and Block Diagram

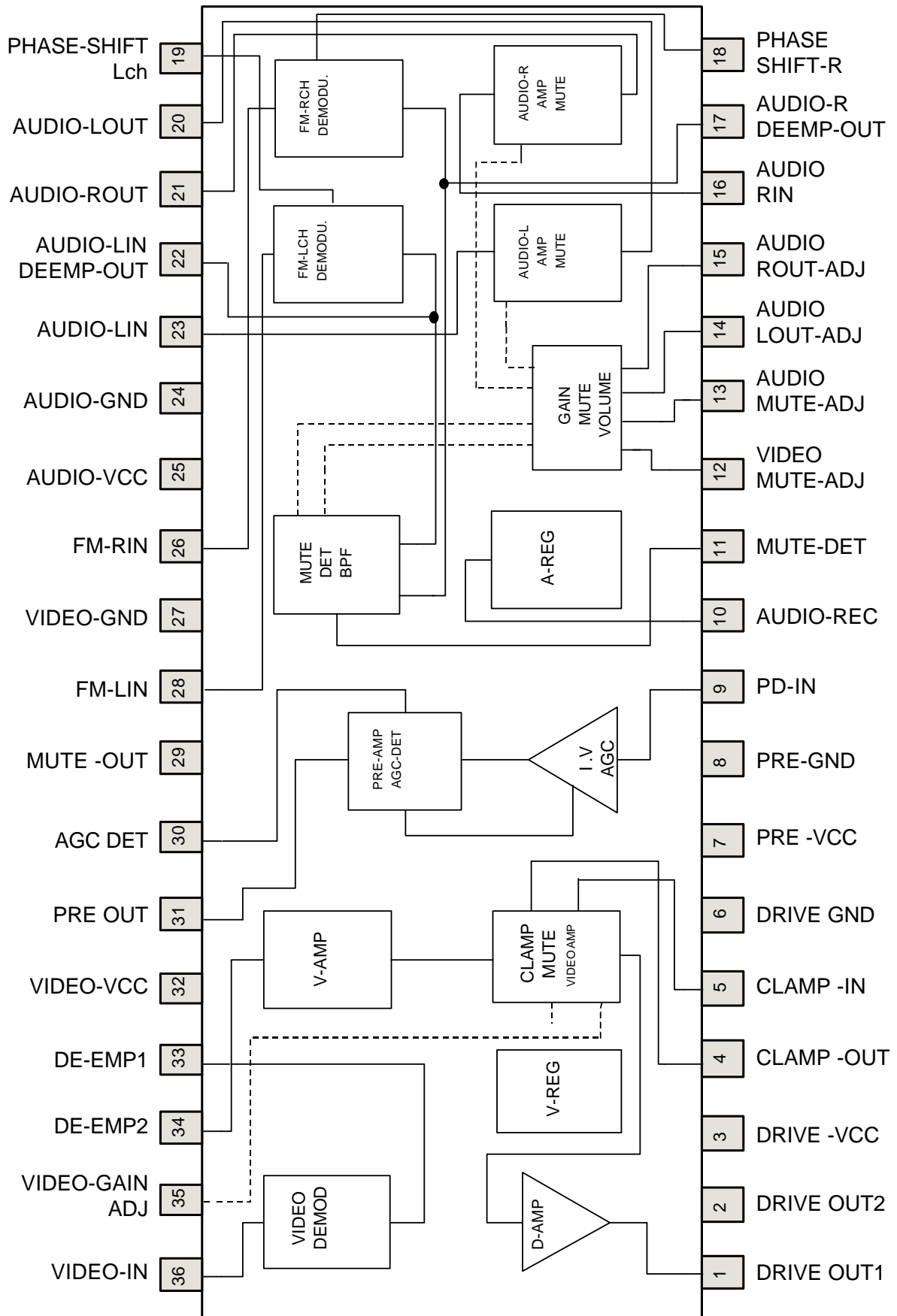

Application Circuit Diagram

This circuit diagram is provided for reference purposes. Applications adopting this design may require optimization.

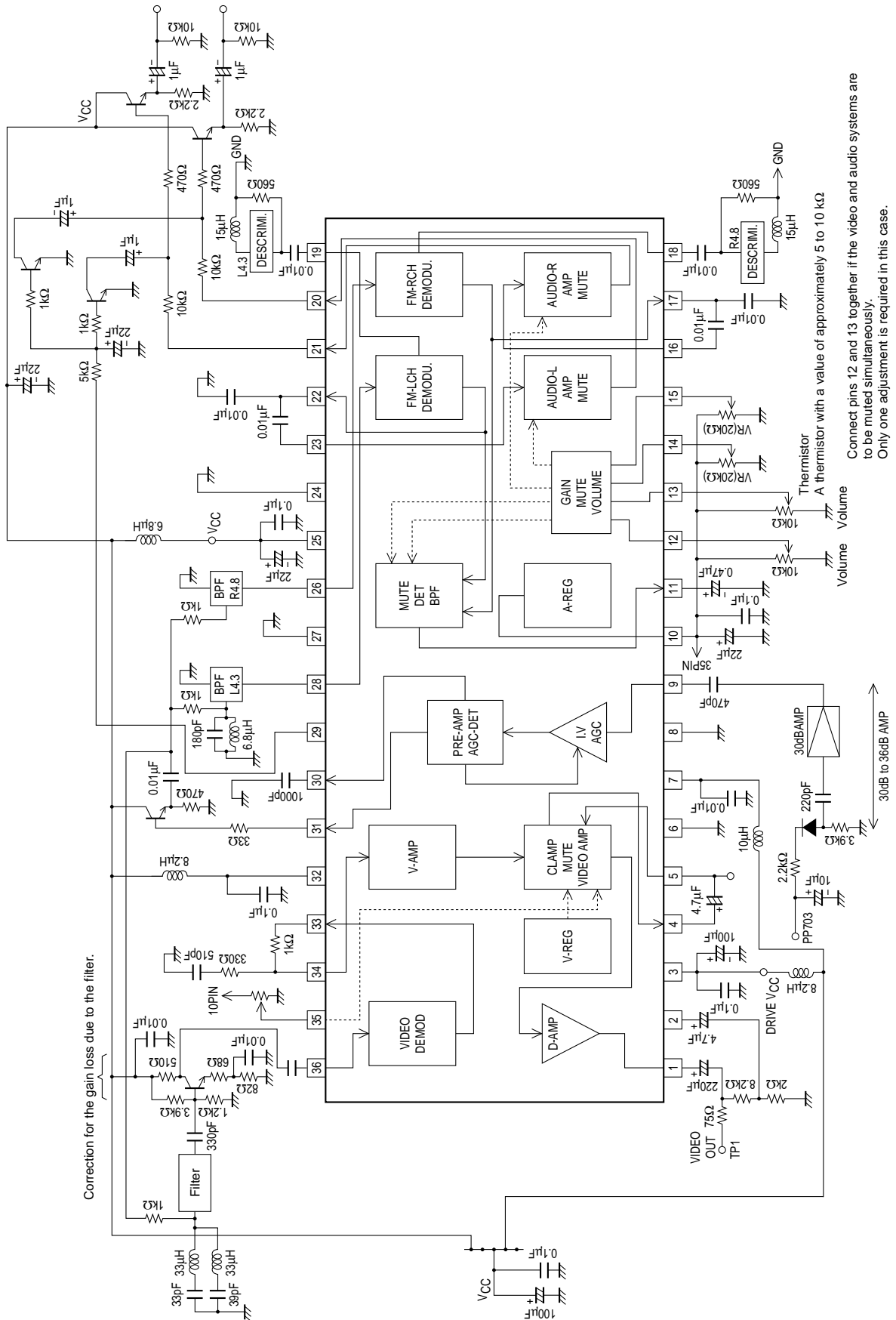

LA9520V

Pin Functions

Pin No.	Pin	Voltage (V)	Function	Equivalent circuit
1	DRIVEOUT	2.1	Video output	<p style="text-align: right;">A13092</p>
2	DRIVEOUT2	2.1	Video output 2	<p style="text-align: right;">A13093</p>
3	DRIVE-V _{CC}	V _{CC}	Driver power supply	
4	CLAMP-OUT	2.7	Sync tip clamp output	<p style="text-align: right;">A13094</p>
5	CLAMP-IN	1.8	Sync tip clamp input	<p style="text-align: right;">A13095</p>
6	DRIVE-GND	0	Driver ground	
7	PRE-V _{CC}	V _{CC}	Preamplifier power supply	
8	PRE-GND	0	Preamplifier ground	
9	PD-IN	1.3	PIN photodiode input The amplifier should have a gain between 30 and 36 dB.	<p style="text-align: right;">A13096</p>
10	AUDIO-REG	1.25	Reference voltage supply bypass capacitor connection	<p style="text-align: right;">A13097</p>

Continued on next page.

LA9520V

Continued from preceding page.

Pin No.	Pin	Voltage (V)	Function	Equivalent circuit
11	MUTE-DET	1.25	Mute detection	<p style="text-align: right;">A13098</p>
12	VIDEO-MUTE ADJ	1.25	Video muting level adjustment	<p>REG = 1.25 V</p> <p style="text-align: right;">A13099</p>
13	AUDIO-MUTE ADJ	1.25	Audio muting level adjustment	<p>REG = 1.25 V</p> <p style="text-align: right;">A13100</p>
14	AUDIO-LOUT ADJ	1.25	Audio left channel output level adjustment	<p>REG = 1.25 V</p> <p style="text-align: right;">A13101</p>
15	AUDIO-ROUT ADJ	1.25	Audio right channel output level adjustment	<p>REG = 1.25 V</p> <p style="text-align: right;">A13102</p>
16	AUDIO-RIN	2.2	Audio right channel input	<p style="text-align: right;">A13103</p>
17	AUDIO-R DEEMP-OUT	1.5	Audio right channel deemphasis output	<p style="text-align: right;">A13104</p>
18	PHASE-SHIFT Rch	3.1	Right channel phase shift	<p style="text-align: right;">A13105</p>
19	PHASE-SHIFT Lch	3.1	Left channel phase shift * Pins 18 and 19 are used to connect ceramic discriminators.	<p style="text-align: right;">A13106</p>

Continued on next page.

LA9520V

Continued from preceding page.

Pin No.	Pin	Voltage (V)	Function	Equivalent circuit
20	AUDIO-LOUT	2.1	Audio left channel output	<p style="text-align: right;">A13107</p>
21	AUDIO-ROUT	2.1	Audio right channel output	<p style="text-align: right;">A13108</p>
22	AUDIO-L DEEMP-OUT	1.5	Audio left channel deemphasis output	<p style="text-align: right;">A13109</p>
23	AUDIO-LIN	2.2	Audio left channel input	<p style="text-align: right;">A13110</p>
24	AUDIO-GND	0	Audio ground	
25	AUDIO-V _{CC}	V _{CC}	Audio power supply	
26	FM-RIN	2.1	FM right channel demodulator input * Ceramic bandpass filter: 4.8 MHz	<p style="text-align: right;">A13111</p>
27	VEDEO-GND	0	Video ground	
28	FM-LIN	2.1	FM left channel demodulator input * Ceramic bandpass filter: 4.3 MHz	<p style="text-align: right;">A13112</p>
29	MUTEOUT	0.03	Muting output Outputs a low level when a carrier is present and a high level when there is no carrier present.	<p style="text-align: right;">A13113</p>

Continued on next page.

LA9520V

Continued from preceding page.

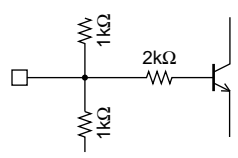
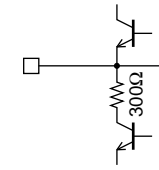
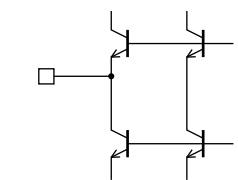
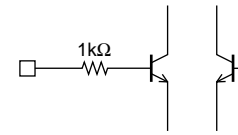
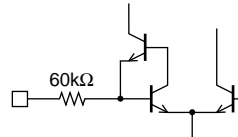
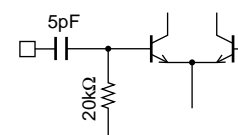
Pin No.	Pin	Voltage (V)	Function	Equivalent circuit
30	AGCDET	4.9	AGC detector	 <p>A13114</p>
31	PREOUT	5.0		 <p>A13115</p>
32	VIDEO-V _{CC}	V _{CC}	Video power supply	
33	DE-EMP1	2.7	Video deemphasis amplifier output	 <p>A13116</p>
34	DE-EMP2	2.7	Video deemphasis amplifier input	 <p>A13117</p>
35	VIDEO-GAIN ADJ	0.7	Video gain adjustment	 <p>A13118</p>
36	VIDEO-IN	0.7	Video input	 <p>A13119</p>

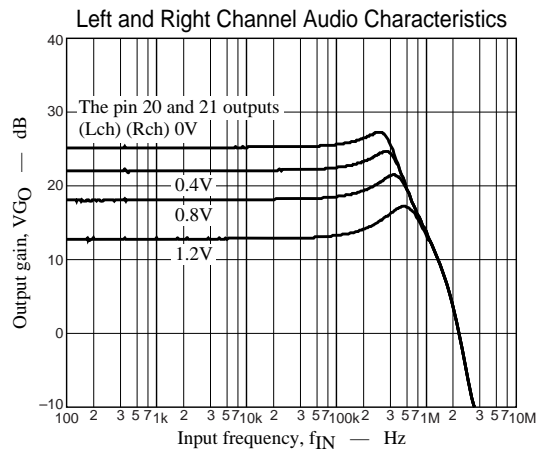
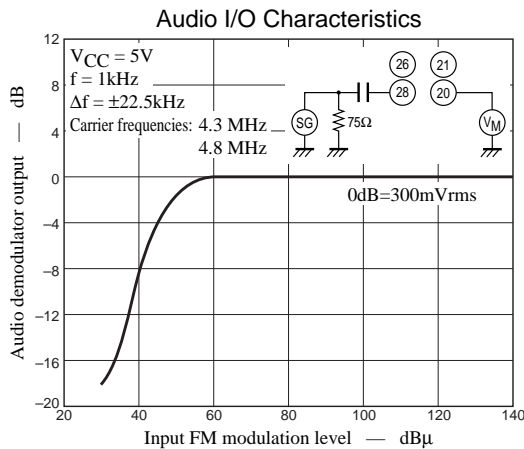
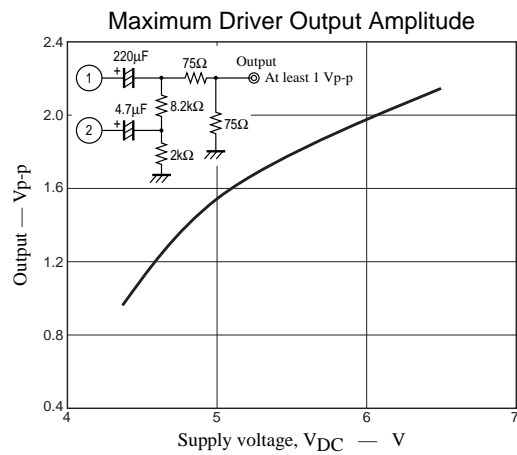
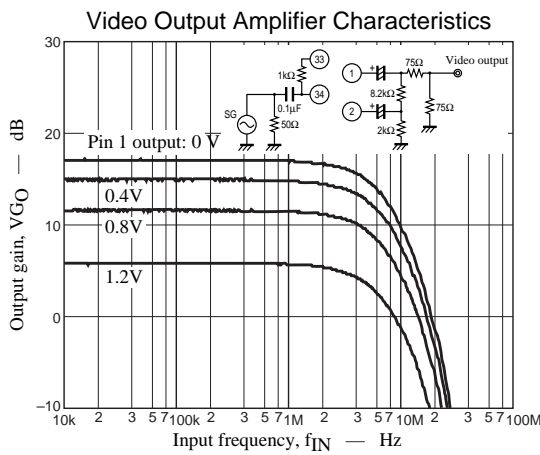
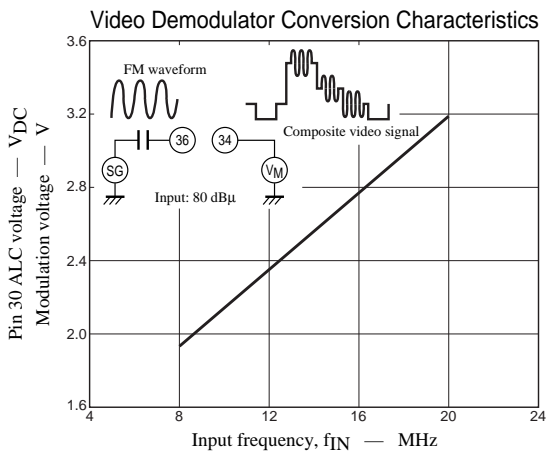
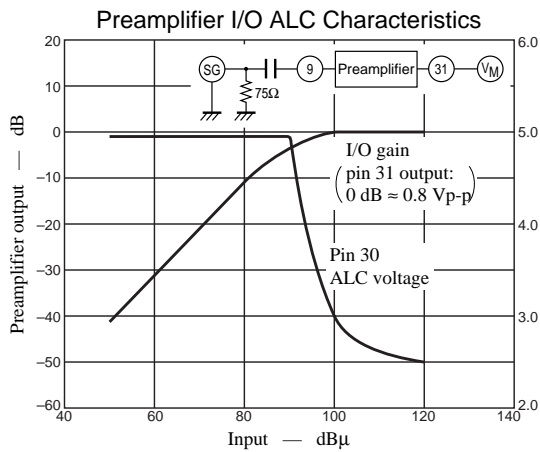
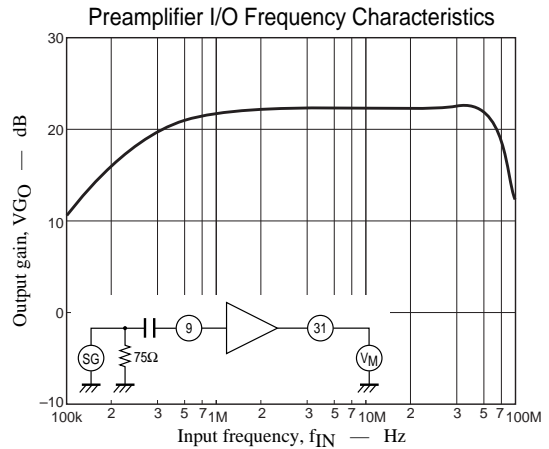
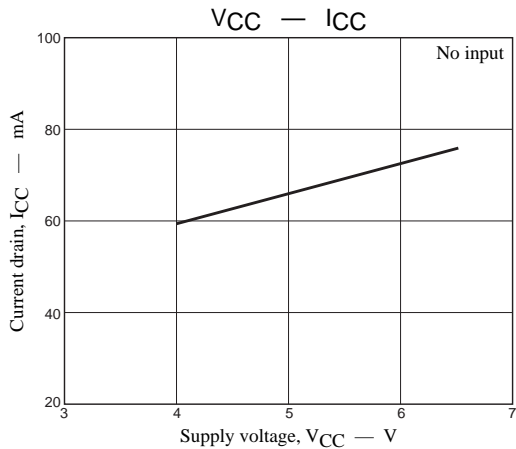

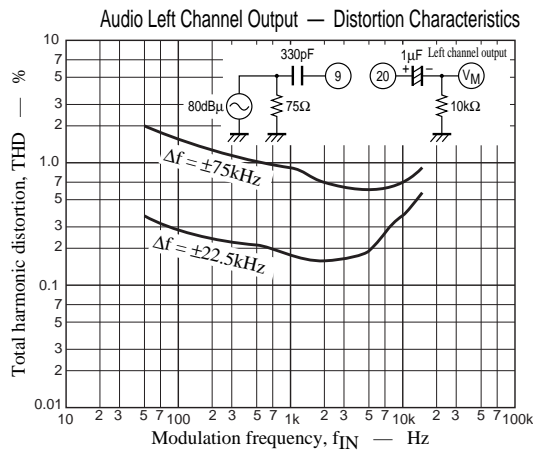
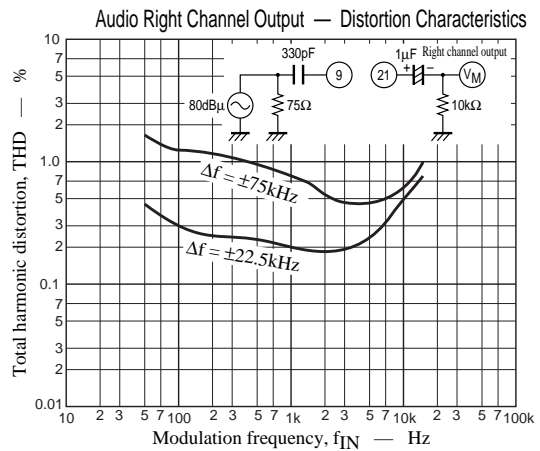
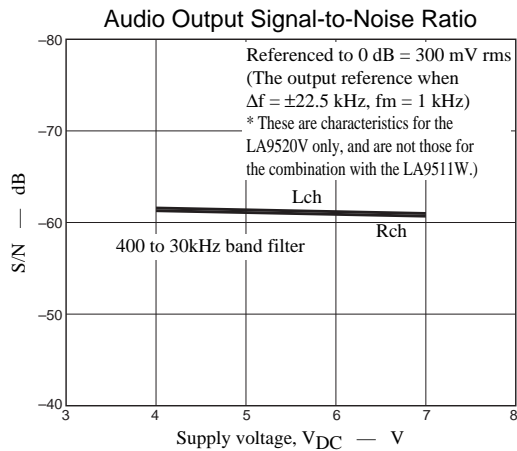

- Specifications of any and all SANYO products described or contained herein stipulate the performance, characteristics, and functions of the described products in the independent state, and are not guarantees of the performance, characteristics, and functions of the described products as mounted in the customer's products or equipment. To verify symptoms and states that cannot be evaluated in an independent device, the customer should always evaluate and test devices mounted in the customer's products or equipment.
- SANYO Electric Co., Ltd. strives to supply high-quality high-reliability products. However, any and all semiconductor products fail with some probability. It is possible that these probabilistic failures could give rise to accidents or events that could endanger human lives, that could give rise to smoke or fire, or that could cause damage to other property. When designing equipment, adopt safety measures so that these kinds of accidents or events cannot occur. Such measures include but are not limited to protective circuits and error prevention circuits for safe design, redundant design, and structural design.
- In the event that any or all SANYO products (including technical data, services) described or contained herein are controlled under any of applicable local export control laws and regulations, such products must not be exported without obtaining the export license from the authorities concerned in accordance with the above law.
- No part of this publication may be reproduced or transmitted in any form or by any means, electronic or mechanical, including photocopying and recording, or any information storage or retrieval system, or otherwise, without the prior written permission of SANYO Electric Co., Ltd.
- Any and all information described or contained herein are subject to change without notice due to product/technology improvement, etc. When designing equipment, refer to the "Delivery Specification" for the SANYO product that you intend to use.
- Information (including circuit diagrams and circuit parameters) herein is for example only; it is not guaranteed for volume production. SANYO believes information herein is accurate and reliable, but no guarantees are made or implied regarding its use or any infringements of intellectual property rights or other rights of third parties.

This catalog provides information as of February, 2002. Specifications and information herein are subject to change without notice.